

Radiotherapy Positioning Solutions

2026 Catalog



Guangdong Meicen Medical Equipment Co., Ltd.

📍 Building 5, Wanyang Innovation Park,
No. 82 Xiaotang Industrial Avenue,
Shishan Town, Nanhai District, Foshan,
528222, Guangdong,
China

✉ sales@meicenmed.com

☎ +86-757-86269115



2026 Catalog



www.meicenmed.com

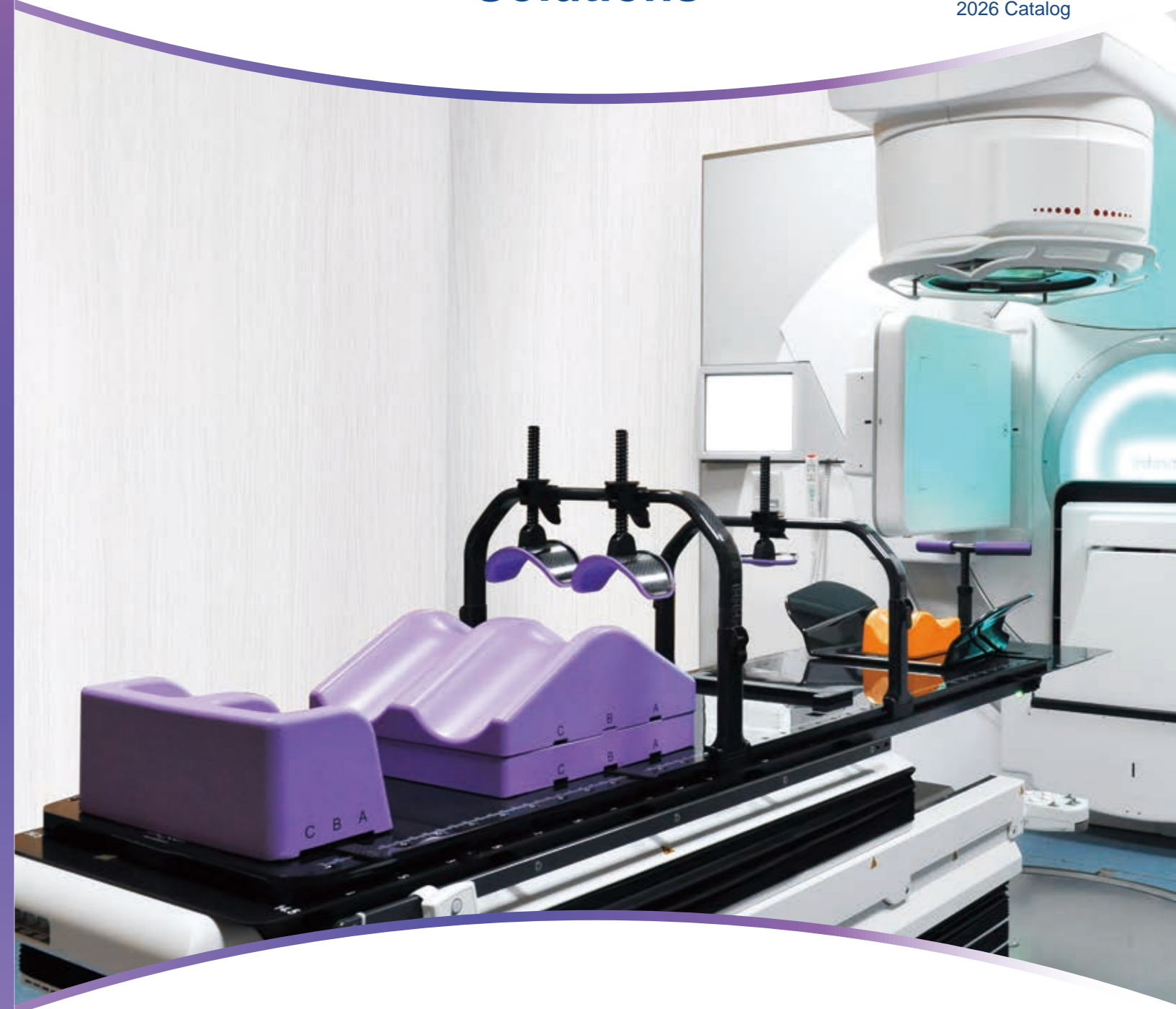

About Us



Guangdong Meicen Medical Equipment Co., Ltd. is an enterprise with independent R&D capabilities, and offering medical equipment R&D manufacturing, sales and services, supported with a more than 8000 square meters' modernized workshops and excellent R&D engineers, technicians, warehouse management and well-trained sales team, which has become one of the core suppliers of thermoplastic sheet materials in the world.

Meicen is dedicated to providing high quality immobilization products for radiotherapy and orthopedic rehabilitation. Its core products include Thermoplastic Masks, Patient Positioning Devices and Components for Radiotherapy, Vacuum Cushions, Thermoplastic Splint Material, Thermoplastic Orthoses and Orthotic Components. All our products are in compliance with ISO13485:2016 certificates, FDA, CE and other international regulations, and have been widely used.

"Quality · Service · Harmony · Innovation" is our company philosophy. We take exquisite technique as core strength, and keep improving and manufacturing supreme products with innovative technology, as well as provide excellent service through scientific management together with our partners around the world.

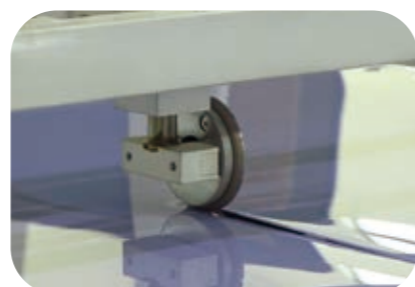
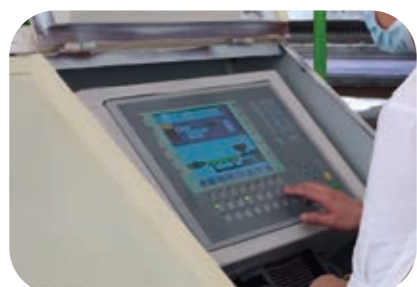

Contents



S-Series Solutions
04-09



C-Series Baseplates
10-14

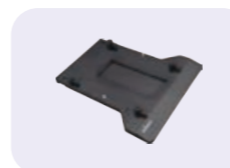

B-Series Baseplates
15



Y-Series Baseplates
16-19

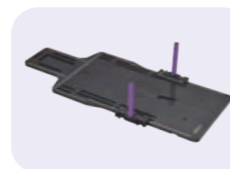

A-Series Baseplates
20-22



W-Series Baseplates
23



R-Series Breast Solutions
24-28



R-Series Prone Belly Solutions
29



Violet Thermoplastic Masks
32-52



Diagnostic Couchtop Overlays
53



Vacuum Cushions
56-58



Accessories
59-61

Violet Thermoplastic Masks

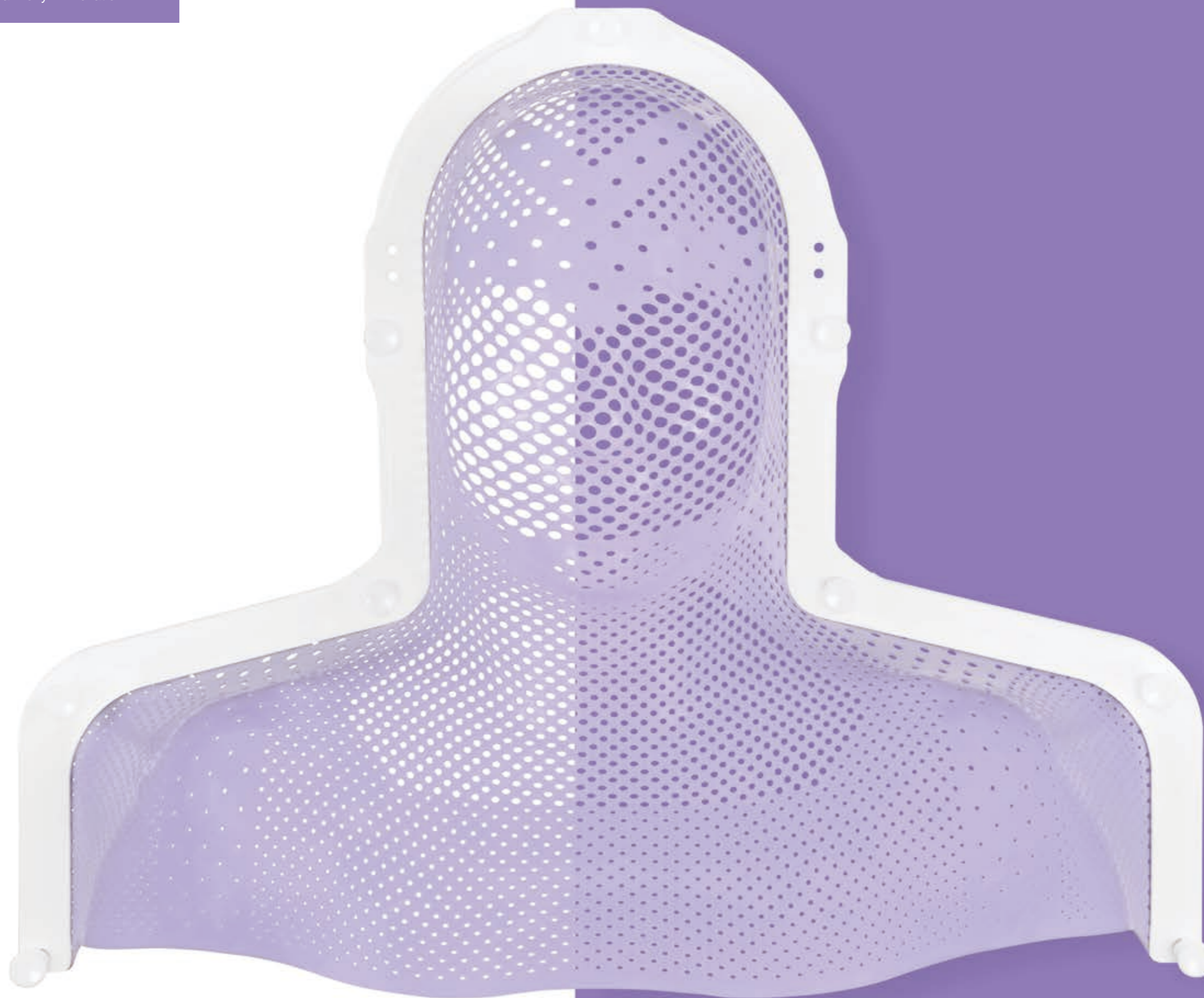

Meicen Violet Thermoplastic Masks

Meicen Violet Thermoplastic Masks are composed of a new, premium thermoplastic material designed specifically to offer the ultimate in patient comfort with exceptional rigidity and extremely low shrinkage, and primary focus is the patient experience. It is available in multiple perforation styles and compatible with most manufacturers' baseplates.



- Ergonomically designed for patient comfort
- Violet color to alleviate patient anxiety
- Optimal molding time
- Low shrinkage
- Non-Stick

Violet a traditional Chinese color that evokes tranquility and harmony. Reminiscent of subtle hues reflected in snow, it creates an ethereal, serene atmosphere. With its timeless quality, violet inspires the imagination and reflects a static beauty—calm, peaceful, and unhurried. In Chinese culture, such colors carry deep artistic significance, symbolizing the pursuit of inner peace and harmony with nature.



Meicen Violet Thermoplastic Masks

Meicen Reinforced Series Masks feature a combination of enhanced perforation and solid thermoplastic to provide rigidity and secure immobilization for IMRT treatments. Openface Masks can be compatible with SGRT (Surface Guided Radiation Therapy) camera systems.

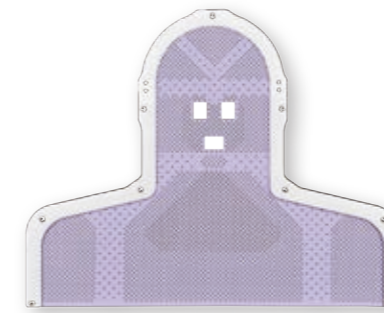

S-type Reinforced Openface

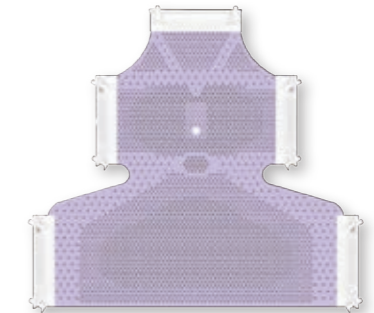

P-type Reinforced

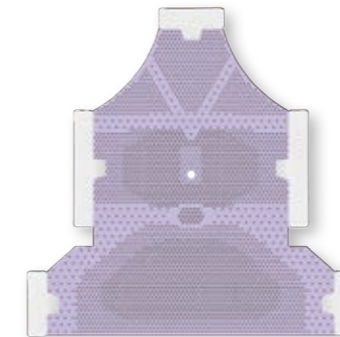

L-type Reinforced

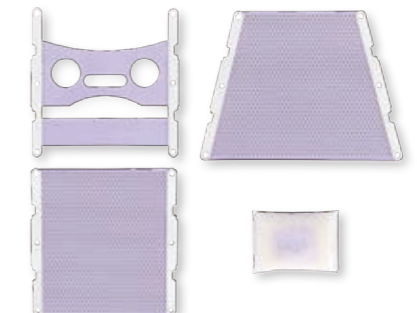

Stereotactic X-Knife

Meicen Violet Thermoplastic Masks are easy to prepare and can be heated by water bath at 65 - 70°C (149 - 158°F) or oven at 70 - 75°C (158 - 167°F).

Moulding Time: **1 - 2 minutes**

Cooling Time: **8 - 15 minutes**

Thickness 2.4mm, 3.0mm are available.

Please contact our sales representative for more information.



U-type Violet Thermoplastic Masks **Slim Frame**



U-type Violet Thermoplastic Masks **Standard Frame**



U-Shaped Head Mask

Standard

M2422-VUA192W	22% perforation, 2.4mm
M3038-VUA481W	38% perforation, 3.0mm
M2415-VUA150W	15% perforation, 2.4mm



U-Shaped Head Mask

Standard

M2422-VUA190W	22% perforation, 2.4mm
M3038-VUA480W	38% perforation, 3.0mm



U-Shaped Head Mask

Reinforced

M24RA-VUA580W	2.4mm
M30RA-VUA610W	3.0mm



U-Shaped Head Mask

Reinforced

M24RA-VUA581W	2.4mm
M30RA-VUA611W	3.0mm



U-Shaped Head Mask

Reinforced, Openface

M24RB-VUA640W	2.4mm
M30RB-VUA670W	3.0mm



U-Shaped Head Mask

Reinforced, Openface

M24RB-VUA642W	2.4mm
M30RB-VUA672W	3.0mm



U-Shaped Head Mask

Reinforced, Open eyes & mouth

M24RB-VUA641W	2.4mm
M30RB-VUA671W	3.0mm



U-Shaped Head Mask

Reinforced, Open eyes & mouth

M24RB-VUA643W	2.4mm
M30RB-VUA673W	3.0mm



U-Shaped Head Mask

Standard, Extended

Extended 5cm		Extended 9cm
M2422-VUA197W	M2422-VUA200W	22% perforation, 2.4mm
M3038-VUA482W	M3038-VUA483W	38% perforation, 3.0mm



U-Shaped Head Mask

Standard, Extended

Extended 5cm		Extended 9cm
M2422-VUA194W	M2422-VUA202W	22% perforation, 2.4mm
M3038-VUA484W	M3038-VUA485W	38% perforation, 3.0mm

Meicen U-type Masks fit all standard U-type Baseplates from Meicen and other manufacturers.

2.0mm & 3.2mm thickness are available also, please specify thickness when requesting a quote.

S-type Violet Thermoplastic Masks



S-Shaped Head Mask

Standard

M2422-VSA190W	22% perforation, 2.4mm
M3038-VSA480W	38% perforation, 3.0mm
M2415-VSA150W	15% perforation, 2.4mm



S-Shaped Head Mask

Reinforced

M24RA-VSA580W	2.4mm
M30RA-VSA610W	3.0mm



S-Shaped Head Mask

Standard, Extended

Extended 5cm	Extended 9cm	
M2422-VSA192W	M2422-VSA193W	22% perforation, 2.4mm
M3038-VSA482W	M3038-VSA483W	38% perforation, 3.0mm



S-Shaped Head Mask

Reinforced, Extended

Extended 5cm	Extended 9cm	
M24RA-VSA581W	M24RA-VSA582W	2.4mm
M30RA-VSA611W	M30RA-VSA612W	3.0mm

S-type Violet Thermoplastic Masks



S-Shaped Head-Neck-Shoulder Mask

Standard

M2422-VSB190W	22% perforation, 2.4mm
M3038-VSB480W	38% perforation, 3.0mm
M2415-VSB150W	15% perforation, 2.4mm

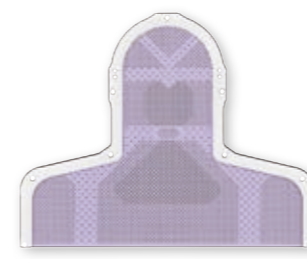

S-Shaped Head-Neck-Shoulder Mask

Reinforced

M24RA-VSB580W	2.4mm
M30RA-VSB610W	3.0mm

Specific design for Meicen C & Y-Series Baseplates

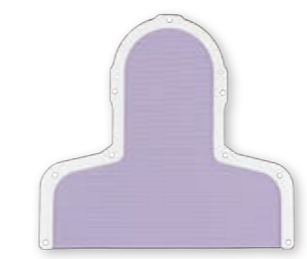

S-Shaped Head-Neck-Shoulder Mask

Standard, narrow shoulder

M2422-VSB191W	22% perforation, 2.4mm
M3038-VSB481W	38% perforation, 3.0mm

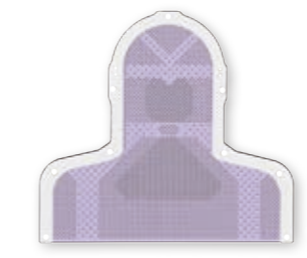

S-Shaped Head-Neck-Shoulder Mask

Reinforced, narrow shoulder

M24RA-VSB581W	2.4mm
M30RA-VSB611W	3.0mm

Meicen S-type Masks fit all standard S-type Baseplates from Meicen and other manufacturers.

2.0mm & 3.2mm thickness are available also, please specify thickness when requesting a quote.

S-type Violet Thermoplastic Masks Openface

Meicen Openface Series Masks aims to alleviate symptoms of claustrophobia during radiotherapy. All types of masks are available as openface. Adjustable pulling of the open part when apply to different patients assures comfort and reinforced effect.



S-Shaped Head Mask
Reinforced, Open eyes & mouth

M24RB-VSA643W	2.4mm
M30RB-VSA672W	3.0mm



S-Shaped Head Mask
Reinforced, Openface

M24RB-VSA640W	2.4mm
M30RB-VSA670W	3.0mm

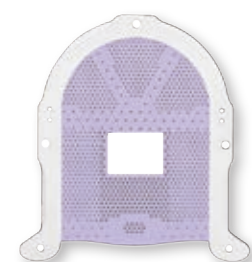

S-Shaped Head Mask
Reinforced, Openface

M24RB-VSA641W	2.4mm
M30RB-VSA671W	3.0mm

Meicen S-type Masks fit all standard S-type Baseplates from Meicen and other manufacturers.

S-type Violet Thermoplastic Masks Openface



S-Shaped Head-Neck-Shoulder Mask
Reinforced, Openface

M24RB-VSB642W	2.4mm
M30RB-VSB670W	3.0mm



S-Shaped Head-Neck-Shoulder Mask
Reinforced, Open eyes & mouth

M24RB-VSB643W	2.4mm
M30RB-VSB672W	3.0mm

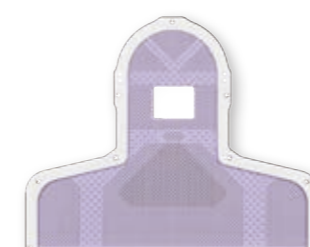

S-Shaped Head-Neck-Shoulder Mask
Reinforced, Openface

M24RB-VSB641W	2.4mm
M30RB-VSB671W	3.0mm

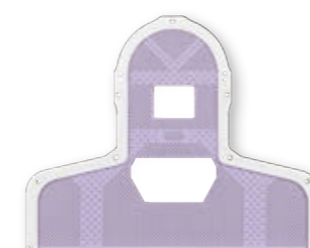

S-Shaped Head-Neck-Shoulder Mask
Reinforced, Open face & neck

M24RB-VSB644W	2.4mm
M30RB-VSB673W	3.0mm

2.0mm & 3.2mm thickness are available also, please specify thickness when requesting a quote.

L-type Violet Thermoplastic Masks



Triangular Head Mask

Standard, with nose hole

M2422-VLA191W	22% perforation, 2.4mm
M3038-VLA480W	38% perforation, 3.0mm
M2438-VLA320W	38% perforation, 2.4mm, for pediatric



Triangular Head Mask

Standard, Extended 3cm, with nose hole

M2422-VLA192W	22% perforation, 2.4mm
M3038-VLA481W	38% perforation, 3.0mm
M2415-VLA151W	15% perforation, 2.4mm



Triangular Head Mask

Reinforced, with nose hole

M24RA-VLA580W	2.4mm
M30RA-VLA610W	3.0mm



Neck-Shoulder Mask

Standard, with nose hole

M2422-VLE190W	22% perforation, 2.4mm
M3038-VLE480W	38% perforation, 3.0mm
M2422-VLE191W	22% perforation, 2.4mm, for pediatric



Neck-Thorax Mask

Standard

M2422-VLF192W	22% perforation, 2.4mm
M3038-VLF480W	38% perforation, 3.0mm

L-type Violet Thermoplastic Masks

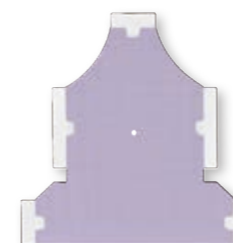

Head-Neck-Shoulder Mask

Standard, with nose hole

M2422-VLB191W	22% perforation, 2.4mm
M3038-VLB481W	38% perforation, 3.0mm
M2422-VLB192W	22% perforation, 2.4mm, for pediatric

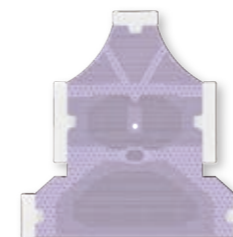

Head-Neck-Shoulder Mask

Reinforced, with nose hole

M24RA-VLB580W	2.4mm
M30RA-VLB610W	3.0mm



Chest-Pelvic Mask

Standard

M3038-VLK483W	38% perforation, 3.0mm, 228 clamp
M3038-VLK482W	38% perforation, 3.0mm, 243 clamp
M3038-VLK481W	38% perforation, 3.0mm, 247 clamp

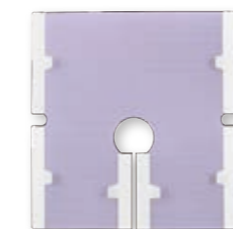

Pelvic Mask

Standard

M3038-VLL483W	38% perforation, 3.0mm, 228 clamp
M3038-VLL482W	38% perforation, 3.0mm, 243 clamp
M3038-VLL481W	38% perforation, 3.0mm, 247 clamp

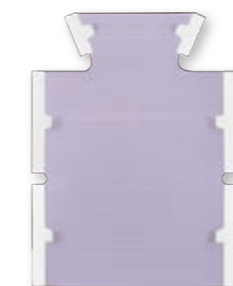

Thorax-Abdomen Mask

Standard

M2422-VLG190W	22% perforation, 2.4mm
M3038-VLG480W	38% perforation, 3.0mm

Meicen L-type Masks fit all standard O-type Baseplates from Meicen and other manufacturers.

2.0mm & 3.2mm thickness are available also, please specify thickness when requesting a quote.

L-type Violet Thermoplastic Masks Openface



Triangular Head Mask

Reinforced, Openface

M24RB-VLA641W	2.4mm
M30RB-VLA671W	3.0mm



Triangular Head Mask

Reinforced, Open eyes & mouth

M24RB-VLA643W	2.4mm
M30RB-VLA673W	3.0mm

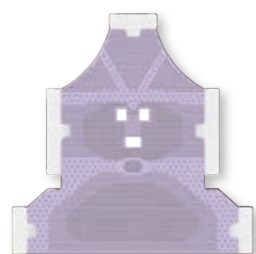

Head-Neck-Shoulder Mask

Reinforced, Open eyes & mouth

M24RB-VLB642W	2.4mm
M30RB-VLB672W	3.0mm



Head-Neck-Shoulder Mask

Reinforced, Openface

M24RB-VLB640W	2.4mm
M30RB-VLB670W	3.0mm

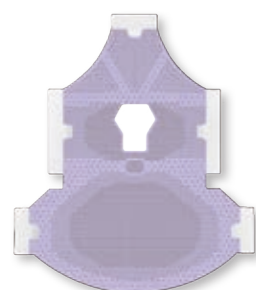

Head-Neck-Shoulder Mask

Reinforced, Extended, Openface

M24RB-VLC641W	2.4mm
M30RB-VLC671W	3.0mm

Meicen L-type Masks fit all standard O-type Baseplates from Meicen and other manufacturers.

P-type Violet Thermoplastic Masks



Triangular Head Mask

Standard, with nose hole

M2422-VPA190W	22% perforation, 2.4mm
M3038-VPA480W	38% perforation, 3.0mm
M2415-VPA150W	15% perforation, 2.4mm



Triangular Head Mask

Reinforced, with nose hole

M24RA-VPA580W	2.4mm
M30RA-VPA610W	3.0mm



Head-Neck-Shoulder Mask

Standard, with nose hole

M2422-VPB190W	22% perforation, 2.4mm
M3038-VPB480W	38% perforation, 3.0mm
M2415-VPB150W	15% perforation, 2.4mm

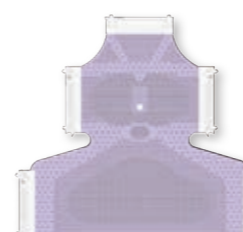

Head-Neck-Shoulder Mask

Reinforced, with nose hole

M24RA-VPB580W	2.4mm
M30RA-VPB610W	3.0mm



Chest-Pelvic Mask

Standard

M2422-VPK190W	22% perforation, 2.4mm
M3038-VPK481W	38% perforation, 3.0mm

P-type Violet Thermoplastic Masks Openface



Triangular Head Mask

Standard, Openface

M24RB-VPA640W	2.4mm
M30RB-VPA670W	3.0mm



Triangular Head Mask

Reinforced, Openface

M24RB-VPA641W	2.4mm
M30RB-VPA671W	3.0mm



Triangular Head Mask

Reinforced, Open eyes & mouth

M24RB-VPA642W	2.4mm
M30RB-VPA672W	3.0mm



Head-Neck-Shoulder Mask

Reinforced, Openface

M24RB-VPB640W	2.4mm
M30RB-VPB670W	3.0mm



Head-Neck-Shoulder Mask

Reinforced, Open eyes & mouth

M24RB-VPB641W	2.4mm
M30RB-VPB671W	3.0mm

Pin-lock type Violet Thermoplastic Masks

Compatible with Meicen C & Y-Series Baseplates



Neck-Thorax Mask

Reinforced

M24RA-VSF580W	2.4mm
M30RA-VSF610W	3.0mm



Trunk Mask (Chest-Pelvic)

Standard

M2422-VST190W	22% perforation, 2.4mm
M3038-VST480W	38% perforation, 3.0mm



Trunk Mask (Pelvic)

Standard, with Groin Lock

M2422-VST191W	22% perforation, 2.4mm
M3038-VST481W	38% perforation, 3.0mm

2.0mm & 3.2mm thickness are available also, please specify thickness when requesting a quote.

H-type Violet Thermoplastic Masks



Trunk Mask (Chest-Pelvic)

Standard

M2422-VHT190W	22% perforation, 2.4mm
M3038-VHT480W	38% perforation, 3.0mm



Trunk Mask (Pelvic)

Standard, with Groin Lock

M2422-VHT191W	22% perforation, 2.4mm
M3038-VHT481W	38% perforation, 3.0mm



Trunk Mask (Chest-Pelvic)

Reinforced

M24RA-VHT580W	2.4mm
M30RA-VHT610W	3.0mm



Trunk Mask (Chest-Pelvic)

Solid

M2400-VHT120W	2.4mm
M3000-VHT420W	3.0mm

2.0mm & 3.2mm thickness are available also, please specify thickness when requesting a quote.

X-Knife Violet Thermoplastic Masks

Meicen X-Knife Violet Thermoplastic Masks are composed of a new, premium thermoplastic material designed specifically to offer the ultimate in patient comfort with exceptional rigidity and extremely low shrinkage. Additionally, the X-Knife Violet Thermoplastic Masks have a non-stick coating applied to the patient-facing mask surfaces, helping ensure that the masks do not stick to the patient's hair, beard, etc.

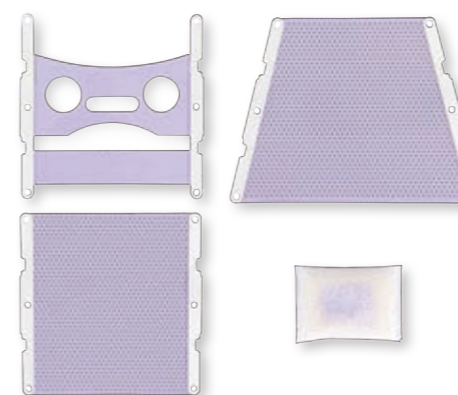

X-Knife Mask
M3038-VXA481W

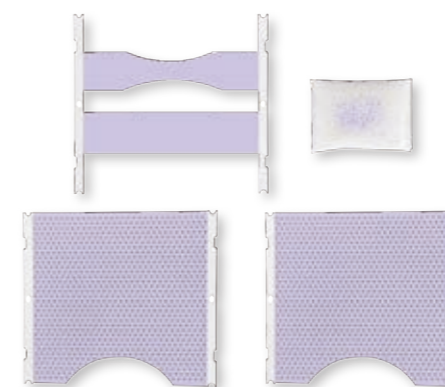

X-Knife Mask
M3038-VXA490W

- Easy to manipulate and mould
- Adhesive Layers
- Low shrinkage
- Cost-effective

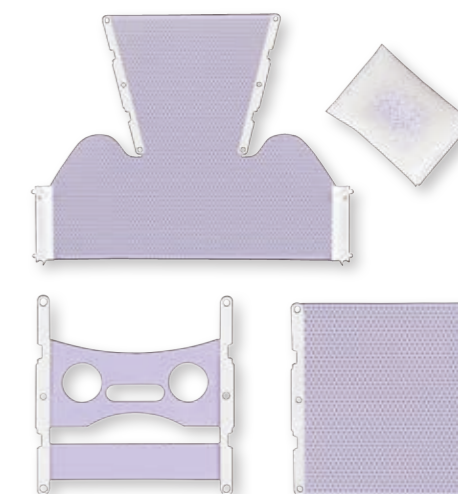

X-Knife Head-Shoulder Mask
M3038-VXB480W

E-type Violet Thermoplastic Masks



Head Mask

Standard

M2422-VEA190W	22% perforation, 2.4mm
M3038-VEA480W	38% perforation, 3.0mm
M2415-VEA150W	15% perforation, 2.4mm



Head Mask

Reinforced

M24RA-VEA580W	2.4mm
M30RA-VEA610W	3.0mm



Head Mask

Standard, Extended 5cm

M2422-VEA192W	22% perforation, 2.4mm
M3038-VEA482W	38% perforation, 3.0mm



Head Mask

Standard, Extended 21cm

M2422-VEA193W	22% perforation, 2.4mm
M3038-VEA483W	38% perforation, 3.0mm

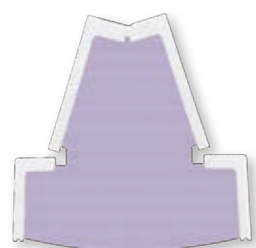

Head-Neck-Shoulder Mask

Standard

M2422-VEB190W	22% perforation, 2.4mm
M3038-VEB480W	38% perforation, 3.0mm
M2415-VEB150W	15% perforation, 2.4mm

E-type Violet Thermoplastic Masks

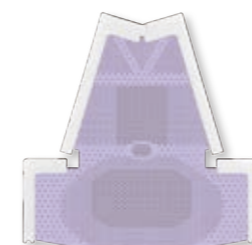

Head-Neck-Shoulder Mask

Reinforced

M24RA-VEB580W	2.4mm
M30RA-VEB610W	3.0mm



Chest-Pelvic Mask

Standard

M3038-VEK480W	38% perforation, 3.0mm
---------------	------------------------



Triangular Head Mask

Reinforced

M24RA-VEA600W	2.4mm
M30RA-VEA620W	3.0mm



Triangular Head Mask

Reinforced

M24RA-VEA602W	2.4mm
M30RA-VEA621W	3.0mm

2.0mm & 3.2mm thickness are available also, please specify thickness when requesting a quote.

V-type Violet Thermoplastic Masks



V-Shaped Head Mask

Standard

M2422-VVA190W	22% perforation, 2.4mm
M3038-VVA480W	38% perforation, 3.0mm



V-Shaped Head Mask

Reinforced

M24RA-VVA580W	2.4mm
M30RA-VVA610W	3.0mm

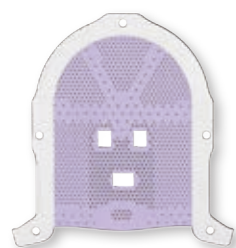

V-Shaped Head Mask

Reinforced, Open eyes & mouth

M24RB-VVA640W	2.4mm
M30RB-VVA670W	3.0mm



V-Shaped Head Mask

Reinforced, Openface

M24RB-VVA641W	2.4mm
M30RB-VVA671W	3.0mm



V-Shaped Head Mask

Standard, Extended

Extended 5cm	Extended 9cm	
M2422-VVA191W	M2422-VVA192W	22% perforation, 2.4mm
M3038-VVA481W	M3038-VVA482W	38% perforation, 3.0mm

V-type Violet Thermoplastic Masks

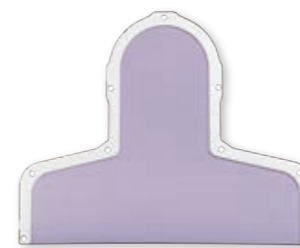

V-Shaped Head-Neck-Shoulder Mask

Standard

M2422-VVB190W	22% perforation, 2.4mm
M3038-VVB480W	38% perforation, 3.0mm

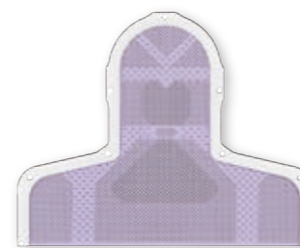

V-Shaped Head-Neck-Shoulder Mask

Reinforced

M24RA-VVB580W	2.4mm
M30RA-VVB610W	3.0mm



V-Shaped Head-Neck-Shoulder Mask

Reinforced, Openface

M24RB-VVB640W	2.4mm
M30RB-VVB670W	3.0mm

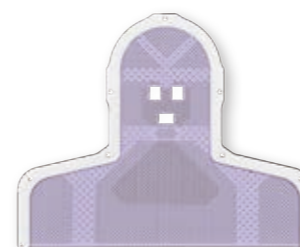

V-Shaped Head-Neck-Shoulder Mask

Reinforced, Open eyes & mouth

M24RB-VVB641W	2.4mm
M30RB-VVB671W	3.0mm

Meicen Violet Thermoplastic Sheets

Meicen Violet Thermoplastic Sheets offer flexible solution for radiation therapy immobilization, available in a wide variety of thickness, perforation and dimension.

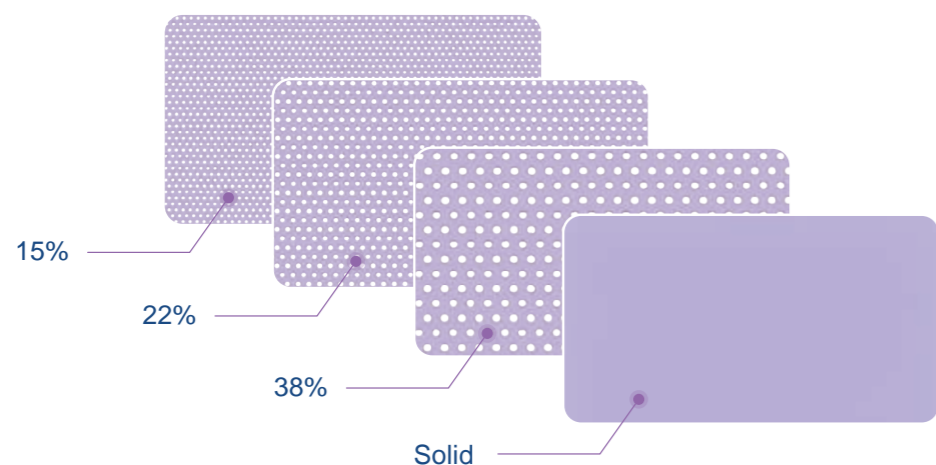

REF No.	Dimension	Thickness	Perforation
M2415-VRT150	900x600x2.4mm	2.4mm	15%
M2422-VRT190	900x600x2.4mm	2.4mm	22%
M2438-VRT320	900x600x2.4mm	2.4mm	38%
M3038-VRT480	900x580x3.0mm	3.0mm	38%
M2422-VRT191	600x450x2.4mm	2.4mm	22%
M3038-VRT481	600x450x3.0mm	3.0mm	38%
M2400-VRT121	600x450x2.4mm	2.4mm	Solid
M3000-VRT420	600x450x3.0mm	3.0mm	Solid

2.0mm & 3.2mm thickness are available also, please specify thickness when requesting a quote.

Meicen Diagnostic Couchtop Overlays

- The Couchtop Overlays provide a clean, flat surface for accurate and easily reproducible patient positioning.
- The internal density distribution of the product is uniform, and there is no unacceptable artifact in the scanning area.
- Can be quickly installed and disassembled, simple and convenient.
- It is stable and reliable after installation and meets the leveling requirements.
- The Couchtop Overlays are designed to work with Indexing bars as well as other positioning systems.

* The Couchtop Overlays can be customized according to the user's CT or MRI equipment.

MC-CTF019 CT Overlay



Also Available As MR Compatible

MC-MRG002

MR



Vacuum Cushions



Meicen Vacuum Cushions

The Meicen Vacuum Cushions offer a rigid and secure support around the patients. The coated nylon shell protects them from tear and stain. The Vacuum Cushions are completely air-tight, leak proof, easy clean and fill with optional density particles made from polyamide. Built-in indexing bars, different size and shape of Vacuum Cushions are available.



- Ultra durable, high-quality polyamide
- Radio-translucent
- Easy to clean
- Cost-effective
- Adapters available for any manufacturer's pump
- Dark blue color distinguishable in optical imagers

Meicen Vacuum Cushions



Non-indexed



Indexed



CT Valve



MR Valve



Indexing Bar



Adapter

Rectangular Vacuum Cushions

CT	MR	Dimensions	Fill	Indexed	
RC-E5003 RC-E5005S	RM-E5003 RM-E5005S	100x70cm	30L	/ W/Indexed	for chest-pelvic support
RC-E4013 RC-E4014F	RM-E4013 RM-E4014F	70x70cm	20L	/ W/Indexed	for breast support
RC-E5024 RC-E5025S	RM-E5024 RM-E5025S	120x80cm	32L	/ W/Indexed	for chest-pelvic support
RC-E5010 RC-E5012S	RM-E5010 RM-E5012S	100x75cm	30L	/ W/Indexed	for chest-pelvic support
RC-E5023S	RM-E5023S	120x75cm	34L	W/Indexed	for chest-pelvic support
RC-E5032 RC-E5033S	RM-E5032 RM-E5033S	150x75cm	45L	W/Indexed W/Indexed	for chest-pelvic support
RC-E8005	RM-E8005	80x200cm	80L	/	for full-body support
RC-E8020S	RM-E8020S	100x150cm	75L	W/Indexed	for full-body support

Remark: Custom width shall not exceed 140cm, Custom length shall not exceed 250cm.

Meicen Vacuum Cushions



T-Shape Vacuum Cushion
with Open Headrest
RC-E3010F



T-Shape Vacuum Cushion
RC-E3005F



Wing Board Cushion
RC-E4003



S-Shape Vacuum Cushion
RC-E1004

Non-Rectangular Vacuum Cushions

CT	MR	Dimensions	Fill	Shape	
RC-E1005	RM-E1005	75x75cm	15L	Arms up	for breast support
RC-E3005F RC-E3010F	RM-E3005F RM-E3010F	125x110cm	31L 32L	T-Shaped	for thorax-abdomen support
RC-E3019	RM-E3019	105x75cm	28L	Arms up	for thorax-abdomen support
RC-E4003 RC-E4004	RM-E4003 RM-E4004	110x55cm	15L 19L	Wing Board breast	for breast support
RC-E1004	RM-E1004	61x65cm	8L	S-Shaped	for head-shoulder support
RC-E1011F	RM-E1011F	68x61cm	10L	S-Shaped	for head-shoulder support
RC-E1008	RM-E1008	50x70cm	12L	S-Shaped	for head-shoulder support

Accessories

Vacuum Cushion Positioners Strip RC-LBC09

- Carbon Fiber



Vacuum Cushion Positioners Strip RC-LBC03

- Acrylic



Vacuum Pump R-PM002

- 220V voltage
- It has two functions: vacuuming and inflating with two mechanical pressure gauges



Shim

- Shim for Head, RE-HSA04
- Shim for Head-Neck-Shoulder, RE-HSA05



Water Bath 04RF-G2

- Inner size: 70x55x12cm
- Stainless steel material, suitable for 220V voltage



Bolus

- 30x30x0.5cm, 01426
- 30x30x1.0cm, 01427

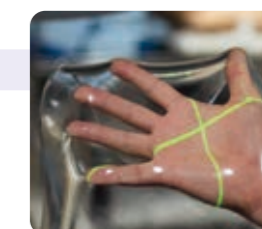

Patient Positioning Devices and Components for Radiotherapy



Meicen S-Series SBRT System

Meicen S-Series SBRT System is highly accurate, comfortable, multi-functional and user-friendly device for SBRT treatment, which is compatible with the couchtops of all brands. The paddle design on the belly and knee bridges can be adjusted in the direction of left and right, up and down to control the breathing range of the patient effectively during the treatment. The operation of quick-lock and unlock system in bridges is effortless.

Specification: 2000(L) x 530(W)/mm

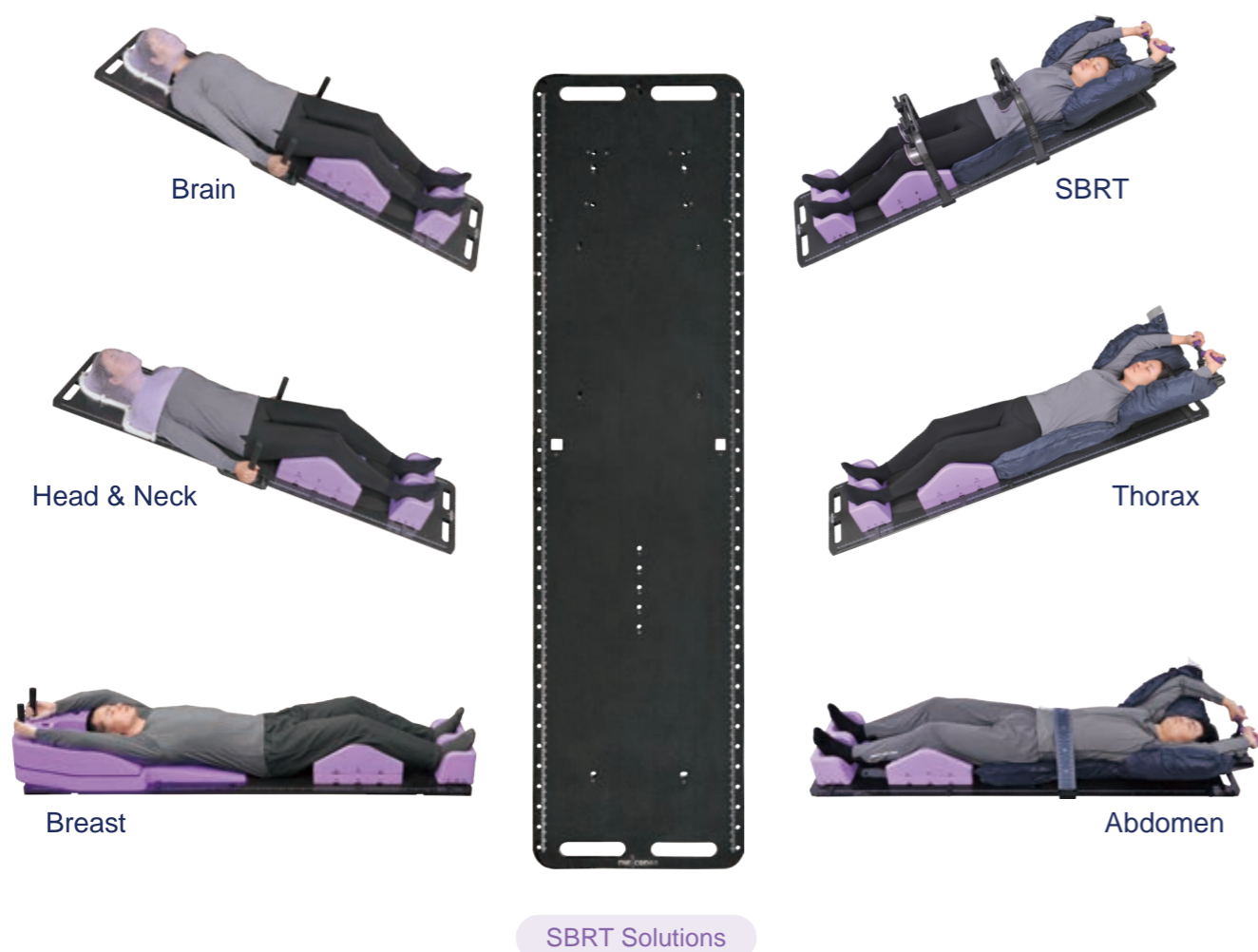

Meicen S-Series SBRT System



• High accuracy

Clear and precise scale, improves the accuracy of positioning repeatability.

• Patient comfort

Ergonomically design for patient comfort.

• Versatility

Multifunctional design, simple to form a set-up for various demand.

• User-friendly

Easy and simple to operate.



SBRT Configuration Components

SBRT Platform

MC-STF001-A01 Carbon Fiber

MC-STG001-A01 Glass Fiber MR

- Multiple corresponding holes, efficient indexing, install without restraint.
- Lightweight, easy to move.



Wing Board T-Grip (Page 53)

MC-WBF001 Carbon Fiber

MC-WBG001 Glass Fiber MR

- T-Grip design provides comfortable arms extension.
- Can be used with the T-Shaped Vacuum Cushion, RC-E3005F or RC-E3010F.



Belly Bridge

MC-STF001-A02 Carbon Fiber

MC-STG001-A02 Glass Fiber MR

- Ergonomic Compression Paddle for better comfort.
- The paddle device can be adjusted in the direction of left and right, up and down, and has scales to record its fixed position.
- Abundant scale marks improve the accuracy of positioning repeatability.



Knee Bridge

MC-STF001-A03 Carbon Fiber

MC-STG001-A03 Glass Fiber MR

- The knee paddle device can be adjusted left and right, up and down, and has scales to record its fixed position.
- Abundant scale marks improve the accuracy of positioning repeatability.
- Knee paddle device is optional in both legs or single leg immobilization.



SBRT Configuration Components

Respiratory Belt

MC-STF001-A04 Carbon Fiber

MC-STG001-A04 Glass Fiber MR

- Provide pneumatic compression and immobilization to the abdominal region.



T-Shaped Vacuum Cushion (Page 30)

RC-E3005F Non-open headrest

RC-E3010F Open headrest

- Open headrest area can be used together with the headrest to reduce the ray blocking.
- Provides arms-up positioning and support the torso region.



Knee & Feet Cushion

RE-FCA01 Knee Cushion

RE-FCA03 Feet Cushion

RE-FCA02 Elevation Cushion

- Easy to operate, improve the comfort and stability of supine position for leg positioning during fixation.
- It can be directly fixed on the couchtop for use.

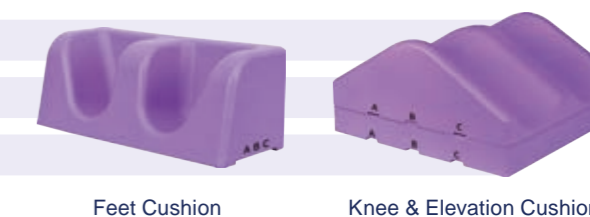

Feet Cushion

Knee & Elevation Cushion

SBRT Indexing Bar

MC-STF001-A07 Carbon Fiber

MC-STG001-A07 Glass Fiber MR

- Allows positioning devices to be fixed to the SBRT Platform for enhancing reproducibility.

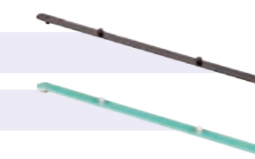

Meicen S-Series SBRT System



Carbon Fiber SBRT System Package

	Component	REF No.	Qty
MC-STF001 Standard Package	SBRT Platform	MC-STF001-A01	1
	Wing Board T-Grip	MC-WBF001	1
	Belly Bridge	MC-STF001-A02	1
	Knee Bridge	MC-STF001-A03	1
	Knee Cushion	RE-FCA01	1
	Elevation Cushion	RE-FCA02	1
	Feet Cushion	RE-FCA03	1
	T-Shaped Vacuum Cushion	RC-E3010F	1
	SBRT Indexing Bar	MC-STF001-A07	4
	Carbon Fiber Headrest	RE-HSF6-B	1
Optional Product	Carbon Fiber Headrest	RE-HSF6	1
	Color Headrest	RE-HSB5	1
	Clear Headrest	RE-HSC6	1
	Respiratory Belt	MC-STF001-A04	1
	Indexing Bar (for E-style indexed couchtops)	RC-LBE02	2
	Indexing Bar (for V-style indexed couchtops)	RC-LBV02	2
Shoulder Retractor	MC-STG001-A08	1	

Meicen S-Series SBRT System



MR SBRT System Package

	Component	REF No.	Qty
MC-STG001 Standard Package	SBRT Platform	MC-STG001-A01	1
	Wing Board T-Grip	MC-WBG001	1
	Belly Bridge	MC-STG001-A02	1
	Knee Bridge	MC-STG001-A03	1
	Knee Cushion	RE-FCA01	1
	Elevation Cushion	RE-FCA02	1
	Feet Cushion	RE-FCA03	1
	T-Shaped Vacuum Cushion	RM-E3010F	1
	SBRT Indexing Bars	MC-STG001-A07	4
	Clear Headrest	RE-HSC6-B	1
Optional Product	Color Headrest	RE-HSB5	1
	Clear Headrest	RE-HSC6	1
	Respiratory Belt	MC-STG001-A04	1
	Indexing Bar (for E-style indexed couchtops)	RM-LBE01	2
	Indexing Bar (for V-style indexed couchtops)	RM-LBV01	2
Shoulder Retractor	MC-STG001-A08	1	

Meicen C-Series AIO Baseplate

The Meicen C-Series AIO Baseplate have a Pin-lock design for easy operation and provide the highest degree of stability for brain, head and neck, thorax, pelvic and full-body support. Dual-configured for both adult and pediatric treatments. The C-Series AIO Baseplate is lightweight and equipped with an adjustable shoulder retractor for shoulder suppression.



Optional Accessories



Color Headrest
RE-HSB5



Overhead Arm Support
RC-ASF01



Shoulder Retractor
MC-CG001-A01



Leg Separator
MC-CG001-A04

Meicen C-Series AIO Baseplate

MC-CF001

- Comfortable shoulder retraction
- Different location choices to provide better immobilization for each patient
- Compatible with standard and narrow shoulder S-type masks
- Configured for multiple treatments

Specification: 1300(L) x 606(W)/mm

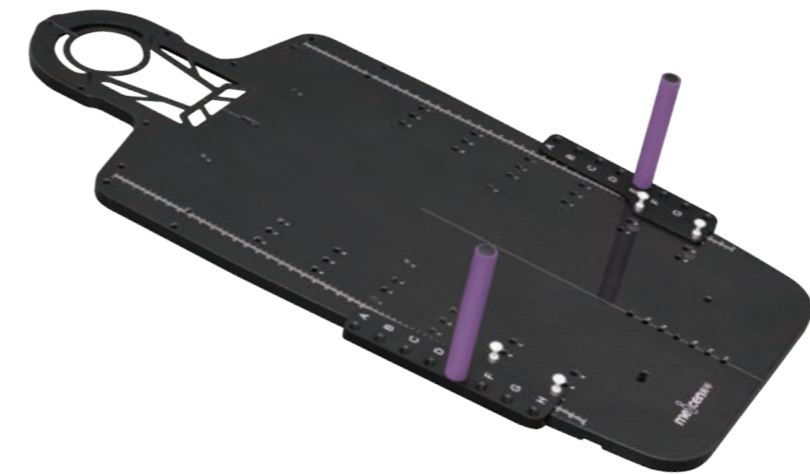

Pins for
fixing headrests



Easily adjustable
Hand Grips



Optional locations for
Leg Separator

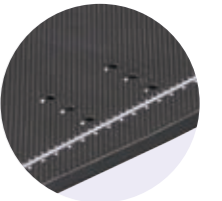

Adjustable to
patient size

Also Available As MR Compatible

MC-CG001

MR



Compatible with



Indexing Bars

Meicen C-Series Head-Shoulder Baseplate

MC-CF002

- The bottom features a curved design for patients comfort
- Different location choices to provide better immobilization for each patient
- Provides the highest degree of stability for the head, neck and shoulders

Specification: 1000(L) x 606(W)/mm

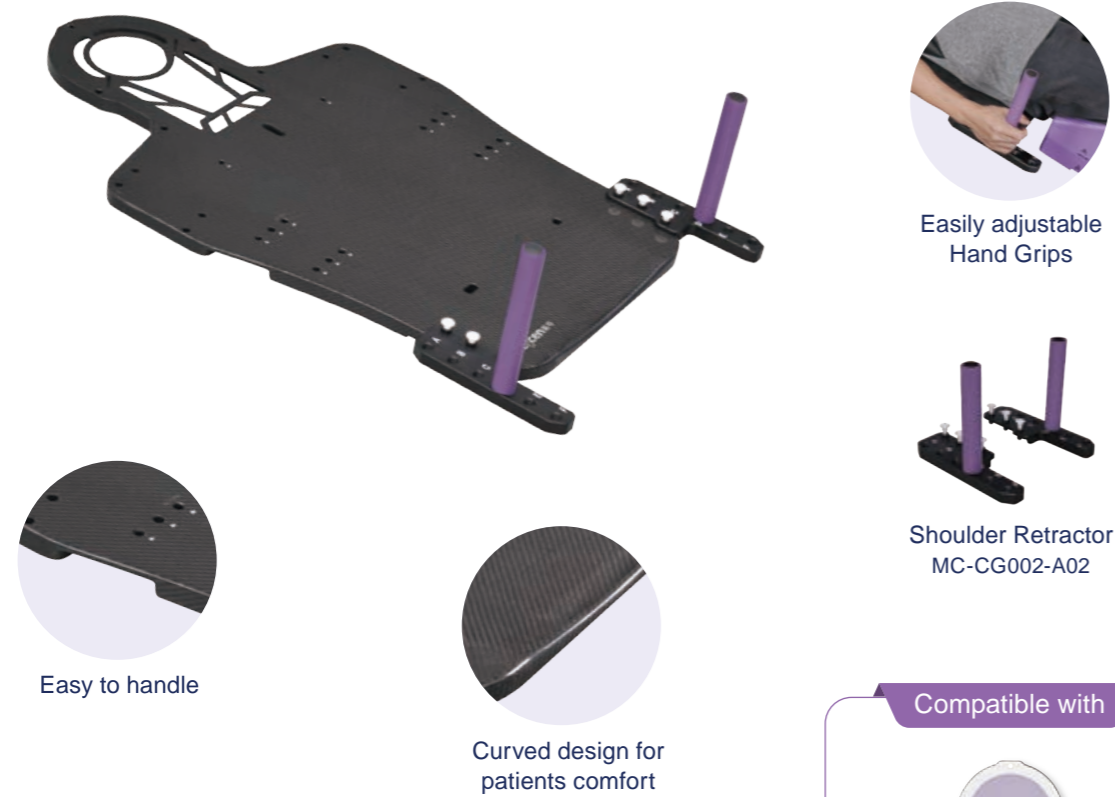

Also Available As MR Compatible

MC-CG002

MR



Meicen C-Series Head-Shoulder Baseplate

MC-CF005

- Provides the highest degree of stability for the head, neck and shoulders
- Configured for standard and narrow shoulder S-type masks

Specification: 1000(L) x 606(W)/mm

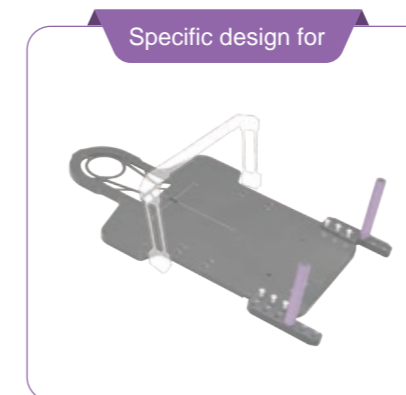
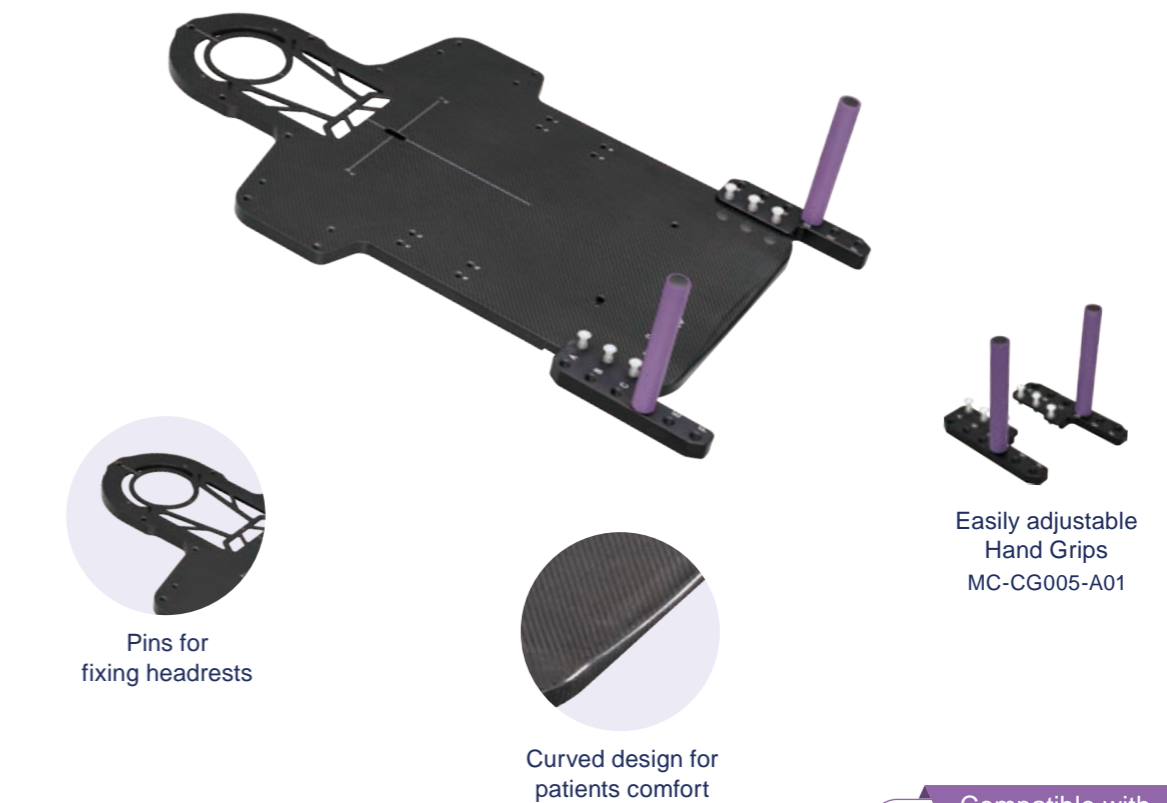

Meicen C-Series Pelvic Baseplate

MC-CF003

- Adjustable scale for different body width
- Side emargination for simple installation and carry
- Contoured design for patients comfort
- Configured for Trunk Masks in S, M and L size
- Provide positioning for leg separator

Specification: 850(L) x 575(W)/mm

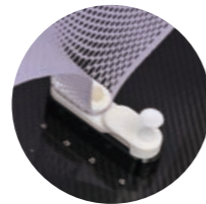

Adjustable to patient size



Curved design for patients comfort

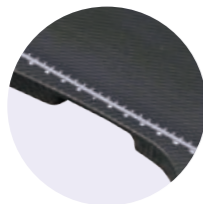

Easy to handle

Also Available As MR Compatible

MC-CG003

MR



Meicen B-Series Baseplate

U-Frame Head Baseplate

MC-BF003

- Provides the head support
- Compatible with all U-frame Masks
- Compatible with Meicen different headrests
- MR compatible MC-BG003

Specification: 366(L) x 420(W)/mm

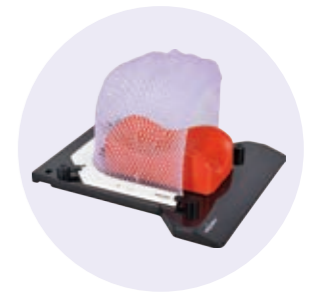

Tilting U-Frame Head Baseplate

MC-BF004

- Provides the head support
- Compatible with all U-frame Masks
- Tilting angles: 5°/10°/20°/25°/30°/35°/40°/45°
- Compatible with Meicen different headrests
- MR compatible MC-BG004

Specification: 377(L) x 306(W)/mm

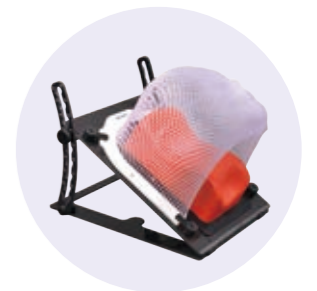

Meicen Y-Series AIO Baseplate

The Meicen Y-Series Baseplate have a Pin-lock design for easy operation, provide the highest degree of stability for brain, head and neck, thorax, pelvic and full-body support. Dual-configured for adult and pediatric treatments. It is compatible with all S-type Masks and Meicen Pin-lock type Masks.

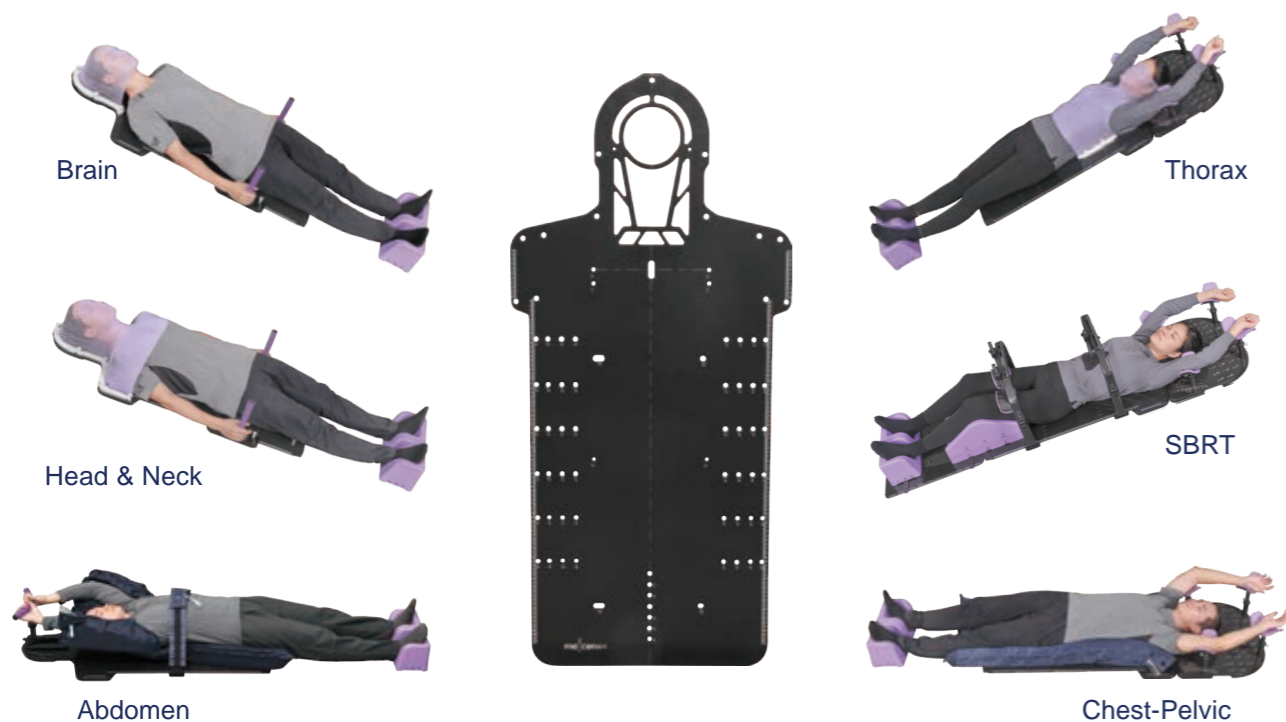

Y-Series AIO Baseplate Solutions

Optional Accessories



Meicen Y-Series AIO Baseplate

MC-YF001

- Compatible with standard and narrow shoulder S-type Masks
- Combined with Belly Bridge to form a SBRT solution
- Different location choices to provide better immobilization for each patient
- Configured for multiple treatments

Specification: 1300(L) x 606(W)/mm

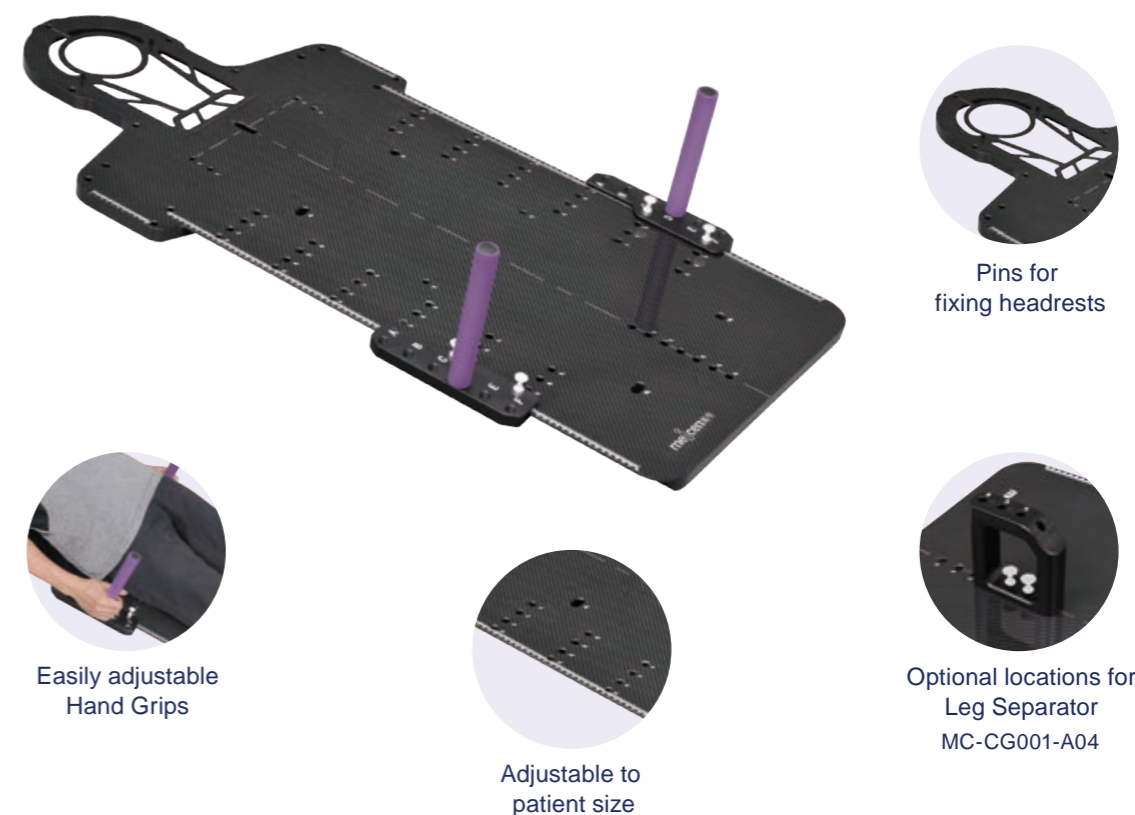

Also Available As MR Compatible

MC-YG001

MR

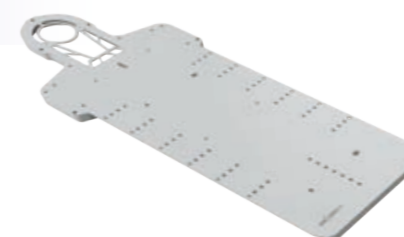

Compatible with



Meicen Y-Series AIO Baseplate

Optional Accessories

Belly Bridge MC-YF001-A01

- Ergonomic Compression Paddle for better comfort.
- The paddle device can be adjusted in the direction of left and right, up and down, and has a scale to record its fixed position.
- Abundant scale marks improve the accuracy of positioning repeatability.
- MR compatible MC-YG001-A01



Knee Bridge MC-YF001-A02

- The knee paddle device can be adjusted left and right, up and down, and has scales to record its fixed position.
- Abundant scale marks improve the accuracy of positioning repeatability.
- Knee paddle device is optional in both legs or single leg immobilization.
- MR compatible MC-YG001-A02



Extension Board RC-EBF01

- Improve the comfort of the patient when positioning.
- Can be fixed directly onto the couchtop.
- MR compatible RM-EBG01

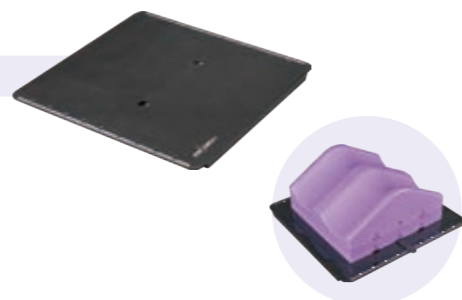

Overhead Arm Support RC-ASF01

- It can be used together with the Meicen C & Y-Series Baseplates to improve the reproducible precision and comfort in breast thorax and lung tumor treatment.
- The height of Wrist Supports and angle of Arm Supports can be adjusted to each patient.
- MR compatible RM-ASG01



Wrist Support
RC-ASF01-A02



Arm Support
RC-ASF01-A01

Meicen Y-Series AIO Baseplate



SBRT Solution Package

Components	CF Package	MR Package	Qty
Belly Bridge	MC-YF001-A01	MC-YG001-A01	1
Knee Bridge	MC-YF001-A02	MC-YG001-A02	1
Extension Board	RC-EBF01	RM-EBG01	1
Overhead Arm Support	RC-ASF01	RM-ASG01	1
Knee Cushion	RE-FCA01	RE-FCA01	1
Elevation Cushion	RE-FCA02	RE-FCA02	1
Feet Cushion	RE-FCA03	RE-FCA03	1
Headrest	RE-HSF6	RE-HSB5	1
Indexing Bar (for E-style indexed couchtops)	RC-LBE02	RM-LBE01	3
Indexing Bar (for V-style indexed couchtops)	RC-LBV02	RM-LBV01	3
Shoulder Retractor	MC-YG001-A03	MC-YG001-A03	1
SBRT Indexing Bar	MC-STF001-A07	MC-STG001-A07	2

Also Available As MR Compatible



Meicen A-Series AIO Baseplate

MC-AF001

- Provides multiple treatment options for head, neck and shoulders, thorax, pelvic and full-body support
- Different location choices to provide better immobilization for each patient
- Shoulder Retractor can be used to improve the accuracy and comfort during treatment

Specification: 1300(L) x 550(W)/mm



Also Available As MR Compatible

MC-AG001

MR



Meicen A-Series Head-Shoulder Baseplate

MC-AF002

- Provides immobilization solution for head, neck and shoulders, breast
- Sides emargination for simple installation and carry
- Contoured design for patient comfort
- Durable and lightweight

Specification: 1000(L) x 550(W)/mm



Also Available As MR Compatible

MC-AG002

MR



Meicen A-Series Baseplate

Pelvic Baseplate

MC-AF003

- Provides immobilization solution for thorax and abdomen
- Sides emargination for simple installation and carry
- Contoured design for patient comfort
- MR compatible MC-AG003

Specification: 850(L) x 520(W)/mm

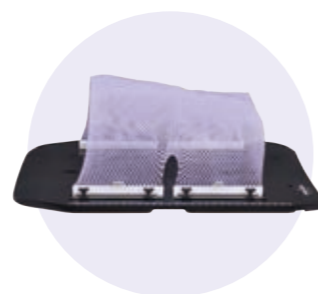

Head-Shoulder Baseplate

MC-AF004

- Provides immobilization solution for head, neck and shoulders
- Compatible with all U-type Masks and L-type Masks
- Compatible with Color Headrest RE-HSP5
- MR compatible MC-AG004

Specification: 550(L) x 550(W)/mm

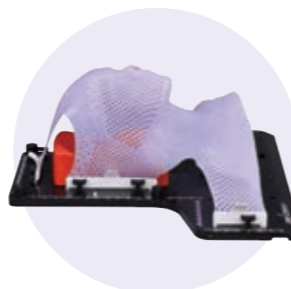

Compatible with



U-type Masks (Page 06-07)



Pelvic Masks



Headrests

Meicen W-Series Wing Board

MC-WBF001 T-Grip

MC-WBF002 U-Grip

- The Meicen Wing Board is durable and lightweight.
- It's easy to use with Vacuum Cushion greatly improves the comfort of the patient's treatment and the accuracy of positioning.
- The patient's arm is raised to maintain a grasping state, which can improve the stability and accuracy of the patient's immobilization.
- It can be used alone, or in conjunction with the Meicen C & Y-Series Baseplates, S-Series SBRT Solution and Supine Breast Board.



Wing Board T-Grip



Wing Board U-Grip

MC-WBF001-A01 T-Grip Carbon Fiber

MC-WBG001-A01 T-Grip MR



RC-HGF01 U-Grip Carbon Fiber

RM-HGG01 U-Grip MR



Also Available As MR Compatible

MC-WBG001

MR



Compatible with



T-Shaped Vacuum Cushion RC-E3010F

Meicen R-Series Breast Solutions

MC-RXE001 Supine Breast Cushions

The Meicen Supine Breast Cushions can be easily installed on Meicen C & Y-Series Baseplates by adapter cushion, or can also be indexed directly to couchtops. The Arm Support Cushions is ergonomically designed for patient comfort. The Hand Grips can be adjusted easily to improve the accuracy and comfort of repeatability.



Ergonomic design for patient comfort



Indexed slot for fixing on couchtops



Easy to install on Meicen Baseplates



The better positioning locations according to patient condition

Compatible with Meicen Baseplates

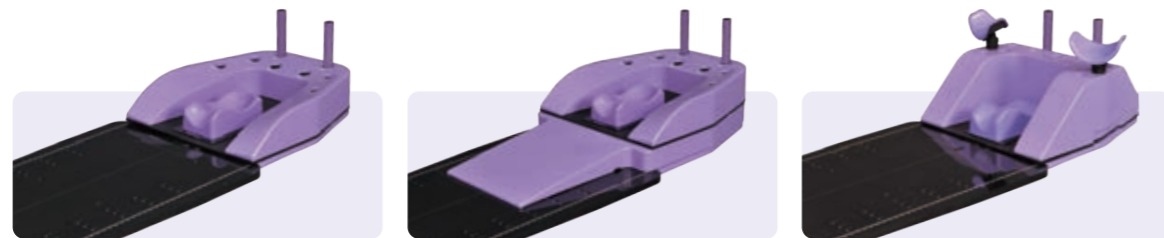

Meicen R-Series Breast Solutions



Wedge Cushion 8°
MC-RXE001-A01



Wedge Cushion 13°
MC-RXE001-A02



Arm Support Cushion (A-type)
MC-RXE001-A03



Arm Support Cushion (B-type)
MC-RXE001-A04



Arm Support Cushion (C-type)
MC-RXE001-A07



Adapter Cushion
MC-RXE001-A05



Color Headrest
RE-HSR5-B

Compatible with couchtops

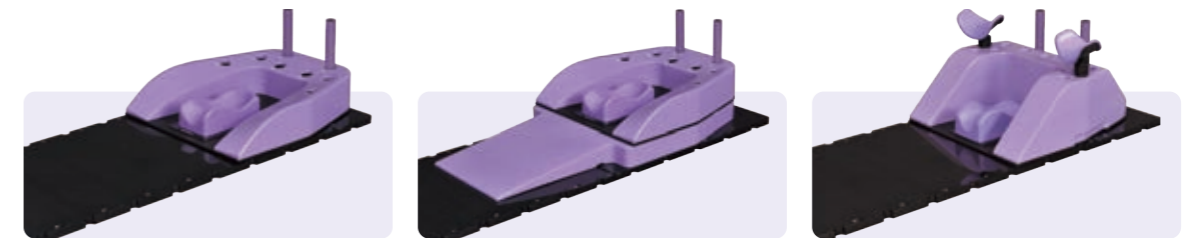

Please contact our sales representative for more solutions.

Meicen R-Series Breast Solutions

MC-RBF001 Prone Breast Board



- Adjustable and durable massage-style face cushion.
- Multiple heterolateral wedge sizes to assist with patient tilt.
- Variable aperture openings to accommodate different breast sizes.
- Scale rulers for easy verification of longitudinal and lateral position of the patient.
- Reversible breast section allows for treatment of either breast.

Specification: 1570(L) x 450(W) x 150(H)/mm



MC-RBG001-A02



MC-RBG001-A03



MC-RBG001-A04



MC-RBG001-A05

Compatible with

M2422-VHT289W Trunk Mask 22% perforation 2.4mm

M3038-VHT550W Trunk Mask 38% perforation 3.0mm

Compatible with Trunk Mask together can be reduced the patient's involuntary displacement and improve the repeatability.

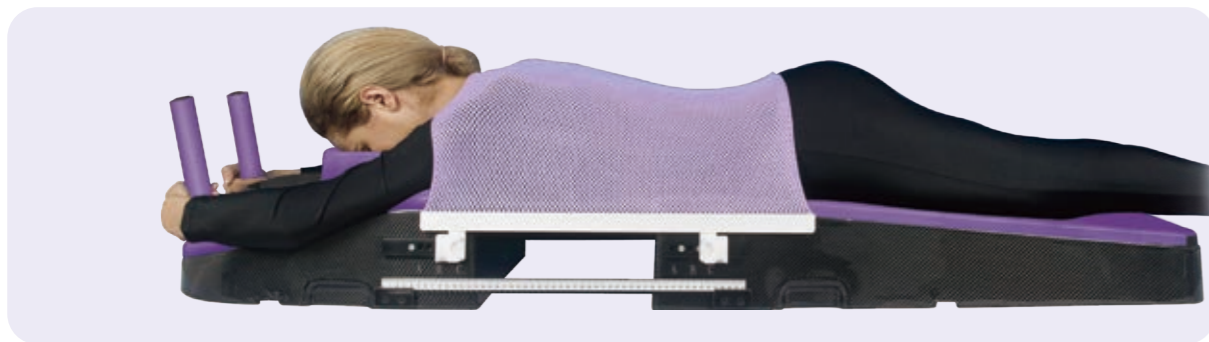
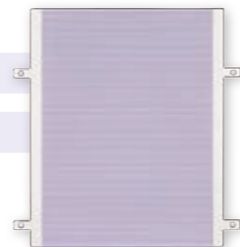

Meicen R-Series Breast Solutions

MC-RXF002 Supine Breast Board



- 5 inclinations: 5°, 10°, 15°, 20° and 25°.
- Simple, customizable setups for patient comfort and clearance.
- Contoured lumbar area and enhanced bottomstop with easy locking.
- Compatible with S-type Head Masks for stable, reproducible supraclavicular treatments.

Specification: 1325(L) x 445(W)/mm

Also Available As MR Compatible

MC-RXG002

MR



Wrist Support
MC-RXF001-A01
MC-RXG001-A01



Arm Support
MC-RXF001-A02
MC-RXG001-A02

Compatible with

M2422-VSH190W Breast Mask 22% perforation 2.4mm

M3038-VSH480W Breast Mask 38% perforation 3.0mm

Compatible with Breast Mask can be reduced the patient's involuntary displacement and improve the repeatability and comfort of the positioning.



Meicen R-Series Breast Solutions

MC-RBE001 Prone Breast Cushion

- The Breast-bridge can be converted left and right according to the treatment plan.
- The U-shaped cushion can be selected S, M, L size.
- The rail-type prone headrest with head to feet direction and the four-levels elevation angle can be adjusted to meet individual needs.
- Compatible with Meicen C & Y-Series AIO Baseplates.



Compatible with

M2422-VST190W Trunk Mask 22% perforation 2.4mm

M3038-VST480W Trunk Mask 38% perforation 3.0mm

Compatible with Trunk Mask together can be reduced the patient's involuntary displacement and improve the repeatability.



Meicen R-Series Prone Belly Solutions

MC-RPE002 Prone Belly Cushion

- The rail-type prone headrest with head to feet direction and the four-levels elevation angle can be adjusted to meet individual needs.
- Dual-configured for female and male treatments.
- Compatible with Meicen C & Y-Series AIO Baseplates.



Prone Headrest



Compatible with

M2422-VST190W Trunk Mask 22% perforation 2.4mm

M3038-VST480W Trunk Mask 38% perforation 3.0mm

Compatible with Trunk Mask together can be reduced the patient's involuntary displacement and improve the repeatability.



Headrests

The headrests included in sets can also be ordered separately, and for other manufacturers' baseplates are available upon request.

Carbon Fiber Headrest RE-HSF6

- Sturdy and durable
- 6 sizes A to F
- Compatible with all S-type Baseplates

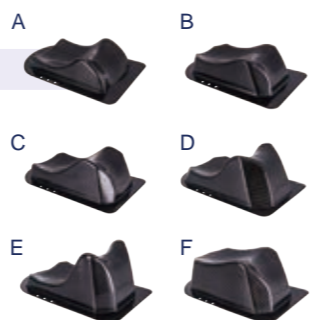

Color Headrest, S-type RE-HSB5

- PU material with customized CT or MR safe, soft and comfortable
- 5 sizes A to E
- Compatible with all S-type Baseplates



Clear Headrest RE-HSC6

- 6 sizes A to F
- Compatible with all S-type Baseplates

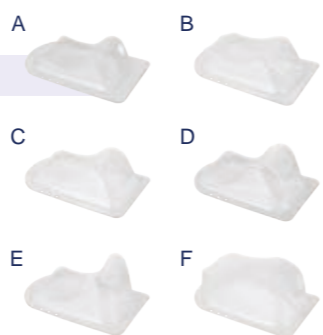

Color Headrest, A-type RE-HSP5

- Customized CT or MR safe, soft and comfortable
- 5 sizes A to E
- Compatible with Meicen A-Series Baseplates

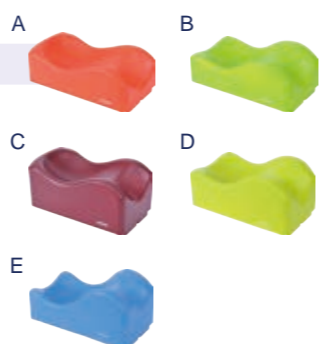

Indexing Bars

For E-style Couchtops

- RC-LBE01 Aluminum
- RC-LBE02 Carbon Fiber
- RM-LBE01 MR compatible



For E-style Couchtops

- RC-LBE04 Carbon Fiber (Sliding)



For V-style Couchtops

- RC-LBV01 Aluminum
- RC-LBV02 Carbon Fiber
- RM-LBV01 MR compatible



For V-style Couchtops

- RC-LBV04 Carbon Fiber (Sliding)

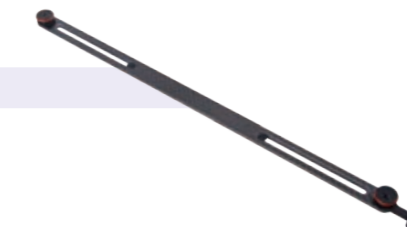

For S-style Couchtops

- RC-LBV08 Carbon Fiber

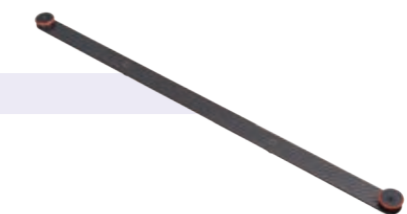

For Vacuum Cushions

- RC-LBC07 Carbon Fiber (Sliding)

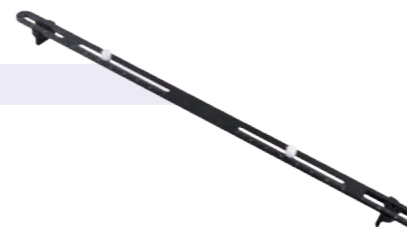

For Meicen C-Series AIO Baseplate

- RC-LBV03 Carbon Fiber for V-style Couchtops
- RC-LBE03 Carbon Fiber for E-style Couchtops

